

Tuning and Analysis of Sliding Mode Controller Based on Fuzzy Logic

G. V. Lakhekar

*Department of Instrumentation Engineering
M. B. E. S. College of Engineering, Ambajogai
gv_lakhekar@rediffmail.com*

Abstract

This paper focused on the design and implementation of a sliding mode controller with fuzzy logic tuning for depth control of an autonomous underwater vehicle (AUV). A fuzzy tuning approach to sliding mode control is employed for enhancing the tracking performance as well as reducing reaching time. The sliding surface can rotate or shift in the phase space in such a direction that the tracking behavior can be improved, which can be carried out using fuzzy tuning method. The reaching time and tracking error in the approaching phase can be significantly reduced. Experimental results indicate the effectiveness of the proposed controller in dealing with model uncertainties, nonlinearities of the vehicle dynamics and environmental disturbances caused by ocean currents and waves.

Keywords: *Sliding mode control, Fuzzy logic tuning, Autonomous underwater vehicle*

1. Introduction

In recent years, numerous worldwide research and development activities have been occurred in underwater robotic vehicles (URV's), because of their emerging applications such as deep sea inspections, long range survey, oceanographic mapping, underwater pipelines, military purpose, and so on. The AUV's motion depend on mode of maneuvering, forward speed, instantaneous attitude and outside appendages such as measuring instruments, tracking sonar, and acoustic telemetry modem. In addition, it is complex to determine system disturbances, cross flow effects and coupling effects. Due to these reasons, design of automatic navigation and robust control systems are needed for giving the robot precision and autonomy. Even though the control problem of underwater vehicle is structurally similar to the control of rigid body in the six degrees of freedom (DOF) widely studied in the literature. However, AUV's dynamics are highly nonlinear and the hydrodynamic coefficients of vehicles are difficult to be accurately estimated a priori because of the variations of these coefficients with different operating conditions. From control point of view, conventional controllers may not be able to handle these difficulties promptly and may cause poor tracking performance. Therefore, control systems of AUV's need to have the capacities of learning and adopting to the unknown nonlinear hydrodynamic effects, parameter uncertainties, internal and external perturbations such as water current or sideslip effect.

Sliding mode control, due to it's robustness against modeling imprecision's and external disturbances, has been successfully employed to the dynamic positioning and motion control of underwater vehicle. Yoerger and Slotine (1985) discuss a sliding mode control scheme for underwater vehicles by splitting the vehicle dynamic in to a series of SISO relationships. The controller effectively deals with nonlinearities and it is robust even with imprecise model and

parametric uncertainty. Later Yoerger and Slotine (1991) developed an adaptive sliding mode control scheme in which a nonlinear system model was used. [3] was designed a hybrid controller by combining an adaptive scheme and sliding mode term to control the motion of remotely operated vehicle (ROV). Meanwhile, [2] an adaptive control scheme for dynamic positioning of an ROV was introduced based on a sliding mode control algorithm that only use position measurements. The application of sliding mode can be extended to the motion control of AUV's.

Sliding mode control is basically a high speed switching feedback control. In general, a sliding motion can be divided in to two phases such as reaching phase and a sliding phase. On the sliding mode, the system invariance properties are observed with their robustness to the disturbance effect. However, during the reaching phase the controller may be sensitive to the structured, unstructured parametric uncertainties and inaccurate mathematical model of the system. Therefore, various control strategies have been suggested by minimizing or eliminating the reaching phase. The straightforward way to reduce tracking error and reaching time to increase the gain of discontinuous control due to it causes chattering effect. The chattering phenomenon is undesirable to the system dynamic which can eliminate with the use of boundary layer thickness. [12] discuss the effect of discontinuous control component on the robust sliding surface. [4] suggested VSS type self tuning scheme based on input-output relations with simultaneous discrete sliding mode control and parameter adaptation.

A moving sliding surface was designed by [1] for fast convergence speed with rotating or shifting surfaces is adaptable to arbitrary initial condition. [8] proposed a robust control performance for eliminating the chattering effect by combing the best features of self organizing fuzzy control and sliding mode control to achieve rapid and accurate tracking control for a class of nonlinear system. [5] introduced a novel sliding mode control with fuzzy logic tuning for accelerating the reaching phase and overcome from the influence of unmodelled uncertainties, which affect in enhancing the system robustness, whereas only linear or linearised systems are considered. Afterwards, fuzzy logic tuning scheme applied to moving sliding surfaces for fast and robust tracking control of nonlinear system. Yi and Chung (1998) employed fuzzy control to substitute the boundary layer terms of sliding mode control in order to improve the chattering behavior. [13] employed fuzzy adapted sliding mode controller, in this approach two fuzzy approximator are involved in such a way that slope of the linear surface is updated by first fuzzy approximator, while second fuzzy approximator regulates behavior of the states in reaching phase. [7] proposed sliding surface can rotate or shift in the phase space in such direction that enhance the tracking behavior with shorten reaching time and tracking error eliminated by using fuzzy tuning approach. [10] proposed an auto tuning method based on fuzzy rules for the selection of control bandwidth (λ) and boundary layer thickness (ϕ) of sliding surface. [9] design sliding mode fuzzy control approach in which moving sliding surface and a boundary layer tuned by fuzzy logic. In the proposed control scheme, a fuzzy tuning scheme applied to sliding mode control for significantly reducing tracking error and reaching time by adaptation of slope (λ), intercept (γ) of sliding surface and gain (K) of discontinuous control. The outline of the paper can be summarized as follows: Section 2 describes sliding mode control law for nonlinear second order system and need of parameter adaptation for sliding hyperplane. Section 3 presents fuzzy logic tuning scheme employed for rotating or shifting sliding surface, so that reaching time and tracking error are reduced. Section 4 describes adaptation of hitting gain for fast tracking response with minimum tracking error. In order to demonstrate the effectiveness of proposed control scheme, certain numerical simulation is performed for controlling depth dynamic of AUV, discussed in Section 5. Finally, in Section 6, we made a brief conclusion on the paper.

2. Problem Formulation

In general, SMC design consists of two phases: the design of the sliding surface and the selection of an appropriate control law. To illustrate the design method, consider a nonlinear second order system equation as follows

$$\ddot{x} = f(x, \dot{x}, t) + bu(t) + d(t) \quad (1)$$

where, $x \in \mathbb{R}^n$ is the state vector, $u \in \mathbb{R}^m$ is the input vector, $b \in \mathbb{R}^n$ is the nominal system matrices, $f(x)$ is a function of state variables and $d(t)$ represents external disturbances.

Let $S(t)$ be a sliding surface defined in the state space by the equations $S(e, \dot{e}) = 0$ with the function $S: \mathbb{R}^2 \rightarrow \mathbb{R}$ satisfying, Slotine and Li (1991)

$$S(e, \dot{e}) = \dot{e} + \lambda e \quad (2)$$

where, e is the tracking error, \dot{e} is the time derivative of error, x_d is the desired trajectory and λ is a strictly positive constant that guarantee the stability of sliding motion. In order to track the system performance with desired trajectory x_d , we define a sliding surface $S=0$ and obtain the control law to satisfy the following sliding condition

$$\frac{1}{2} \frac{d}{dt} S^2 \leq -\eta |S| \quad (3)$$

where, η is a constant related to the reaching time towards sliding surface. This, in turn, implies the following equation

$$\dot{S} = \ddot{e} + \lambda \dot{e} \leq \eta \text{sign}(S) \quad (4)$$

In above Eq. (4) substitute the nonlinear system Eq. (1) then control law is obtain as

$$u = -b^{-1} [f + \lambda \dot{e} + d + K \text{sign}(S)] \quad (5)$$

The signum function in the above Eq. (5) requires infinite switching on the part of the control signal and actuator to maintain the system dynamics on the sliding surface. In practice, actuator limitations, transport delays, computational delays and other factors prevent true sliding and lead to a phenomenon known as ‘‘Chattering’’ in which the states jump back and forth across the sliding manifold while decaying towards the origin. To compensate for this, signum function is replaced by a saturation function

$$\text{Sat}(S) = \begin{cases} -1 & \text{if } \frac{S}{\phi} \leq -1 \\ +1 & \text{if } \frac{S}{\phi} \leq +1 \\ \frac{S}{\phi} & \end{cases} \quad (6)$$

The parameter ϕ defines the thickness of the boundary layer or region in which sliding mode control law is linear. Moreover, the system may be subject to parameter variations and external disturbances. Consequently, the overall control law as given in Eq. (7) may be sensitive to uncertainties during the reaching phase.

$$u = u_{eq} - K \text{Sat}(S) \quad (7)$$

For fast and robust tracking of state variables in both reaching phase and the sliding mode, which is achieved by adjusting slope and intercept of sliding hyperplane. Another way to reduce tracking error and reaching time by selecting appropriate hitting gain (K), which causes to change approaching angle towards switching plane. Therefore these parameters are adapted for accelerating the reaching phase as well as eliminating the tracking error with help of fuzzy logic tuning scheme.

3. Moving Sliding Surface

A moving sliding surface means rotating or shifting sliding surface in phase plane is presented in this section, which includes a fuzzy logic part for updating the slope λ and intercept γ of sliding surface. The main strategy of tuning is to rotate or shift the sliding surface for accelerating the reaching time and reducing parametric uncertainties. The objective is to force the sliding hyperplane towards state errors and make them zero with rapid action. The sliding surface is rotated by selecting possible slope values in between λ_{\max} and λ_{\min} , which indicate the stable zone. The selection of slope values plays an important role in SMC design, which affects tracking accuracy, reaching time and the stability of the system dynamics. The system performance is very sensitive to the slope of the sliding mode function, when the value of λ become large causes degraded tracking performance with longer reaching time that's mean the rise time become small but at the same time both overshoot and settling time become larger, while smaller value of λ leading to longer tracking time and shorten reaching time.

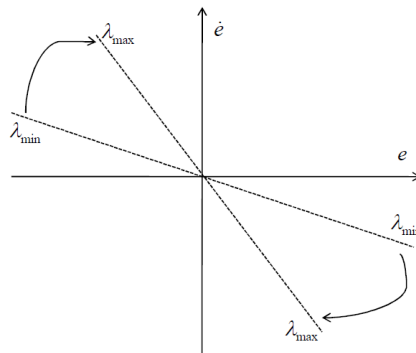

Figure 1. Rotation of Sliding Surface

Figure 1 demonstrates the idea of adaptation scheme for λ . The effectiveness of SMC depends highly upon the value of the sliding line slope. A large value for sliding line slope ensures good performance but too large slope causes instability. At initial stage, adaptation of λ parameter is carried out by using fuzzy logic part with error and change in error as the input variable whereas slope constant is used as output variable, in this adaptation scheme intercept of sliding surface is not taken in to account. The formulation of fuzzy rule for tuning scheme

is based on concepts that a large value of λ causes long reaching time therefore we choose small value of λ for shorten reaching time with condition is that error is large. The membership function of input linguistic variables e and \dot{e} and membership function of output linguistic variable λ are shown in Figure 2. Inputs are decomposed in to three fuzzy partitions expressed as *Negative* (N), *Zero* (Z) and *Positive* (P). Output is a singleton function expressed as *Very Small* (VS), *Small* (S), *Medium* (M), *Large* (L) and *Very Large* (VL). The slope inference system is constructed by the idea of decreasing trajectory convergence time.

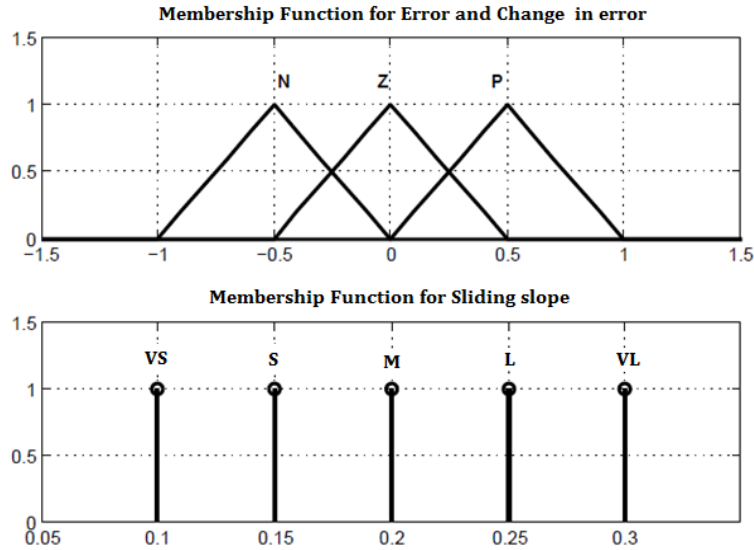

Figure 2. Membership Functions of Input-output Variables for Sliding Slope Inference System

Table 1. The Rule Base for Tuning of Sliding Slope

		e		
		N	Z	P
\dot{e}	N	VS	S	M
	Z	S	M	L
	P	M	L	VL

The fuzzy logic rule base is designed as follows

Rule i: If e is F_1^i and \dot{e} is F_2^i then λ_i is φ_i

where, $F_1^i, F_2^i, i = 1, 2, \dots, m$ are the labels of two input fuzzy sets characterized by fuzzy membership function and $\varphi_i, i = 1, 2, \dots, m$ are the singleton control action. The sliding inference rules are composed as in Table I. The defuzzification of the output is accomplished by the method of centre of gravity.

$$\lambda_{fuzz} = \frac{\sum_{i=1}^m w_i \varphi_i}{\sum_{i=1}^m w_i} \quad (8)$$

The crisp output variable λ_{fuzz} of fuzzy logic tuning scheme is used for rotation of sliding hyperplane results in decreasing the reaching time and improving system performance.

Theorem 1: For a nonlinear system Eq.(1), consider the controller Eq.(7), if the parameter adaptation algorithm is applied then system can guarantee that: (a) The parameters are bounded and (b) Closed loop signals are bounded and tracking error converges asymptotically to zero.

Proof

Let us define a Lyapunov function $V = \frac{1}{2} S^2$ with $S(e, \dot{e}) = \dot{e} + \lambda e$ and the derivative of the lyapunov function can be expressed as

$$\begin{aligned} V &= S\dot{S} = S(\ddot{e} + \lambda\dot{e}) = S[(\ddot{x} - \ddot{x}_d) + \lambda\dot{e}] \\ &= S[f(x) + bu + d - \ddot{x}_d + \lambda\dot{e}] \\ &= S[\hat{f} + \hat{u} - \ddot{x}_d + \lambda\dot{e}] \\ &= S[\hat{f} + u_{eq} - Ksat(S) - \ddot{x}_d + \lambda\dot{e}] \end{aligned}$$

Using the fuzzy tuned expression for the slope value λ_{fuzz} as positive definite crisp value

$$\begin{aligned} \dot{V} &= S[\hat{f} + u_{eq} - (\eta + F)sat(S) + \lambda_{fuzz}\dot{e} - \ddot{x}_d], \quad \eta > 0 \\ \dot{V} &\leq |S|[-(\eta + F)sat(S)] \end{aligned}$$

Therefore, the asymptotic stability condition $\dot{V} = S\dot{S} \leq -\eta|S|$ is satisfied by \dot{V} . This concludes the proof.

The adaptation of sliding surface intercept is need when the initial condition of system dynamics are located in the first and third quadrants due to that robustness derived from rotating sliding surface may be absent during reaching phase. Therefore, we have to shift the sliding surface towards the representative point in order to reduce reaching time. For the shifting of sliding hyperplane consider following surface equation

$$S(e, \dot{e}) = \dot{e} + \lambda e + \gamma \quad (9)$$

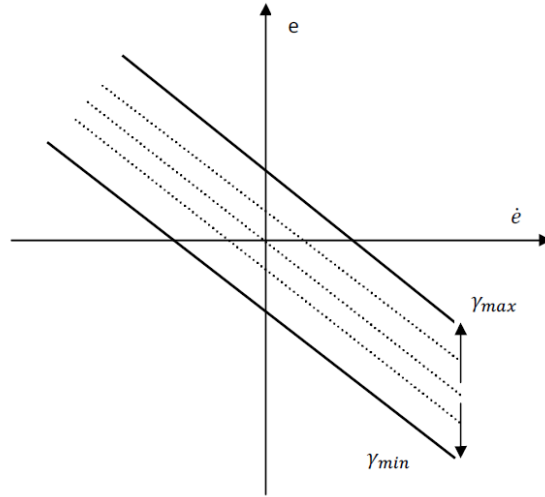

Figure 3. Shifting of Sliding Surface

In above Eq. (9) λ is fixed constant and tune the intercept γ by fuzzy logic part according to error and change in error. Figure 3 shows bounded region between γ_{max} and γ_{min} of shifting sliding plane with possible values of intercept. Here, intercept of sliding plane act as boundary layer, during the condition is that if we choose positive value of γ then sliding plane shifted upward and vice versa. The bounded region in phase plane is determined by the guaranteed tracking performance with their stability. The formulation of rule base for the adaptation of γ based on eliminating the tracking error, which are constructed with consideration is that if γ causes positive tolerance appears in the system performance and vice versa. These considerations result in developing the generalized rule such as if the tracking error is negative then sliding surface should shift upwards and vice versa. The intercept inference system has one output γ and two inputs such as e and \dot{e} . The membership functions of inputs are defined earlier, while output variable is expressed by using singleton functions *Negative Large* (NL), *Negative Medium* (NM), *Negative Small* (NS), *Zero* (Z), *Positive Small* (PS), *Positive Medium* (PM), and *Positive Large* (PL), as shown in Figure 4.

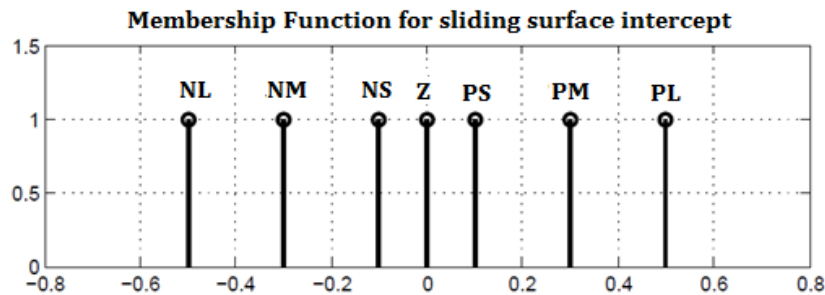

Figure 4. Membership Function of Output Variable for Intercept Inference System

The fuzzy rule base is designed as in Table 2 and the defuzzification of output variable is accomplished by the method of centre of gravity. The intercept of sliding plane is updated

only when the initial condition of the system located in first and third quadrants. According to above condition rule base can be designed for tuning of sliding intercept. Whenever, rotating sliding surface can't gives the robustness in presence of external disturbances then adaptation of sliding intercept is required. The crisp output γ_{fuzz} of fuzzy logic tuning scheme is employed to choose appropriate intercept value for reducing the tracking error.

Table 2. The Rule Base for Tuning of Sliding Intercept

		e		
		N	Z	P
\dot{e}	N	PL	PM	PS
	Z	PM	Z	NM
	P	NS	NM	NL

Theorem 2: *If the sliding mode controller is selected with fixed constant λ and then nonlinear system incorporating the sliding surface Eq. (9), the crisp value of γ_{fuzz} satisfies the sliding condition*

Proof

We define a Lyapunov function $V = \frac{1}{2}S^2$ with $S(e, \dot{e}) = \dot{e} + \lambda e + \gamma$ and the derivative of the lyapunov function can be expressed as

$$\begin{aligned} V &= S\dot{S} = S(\ddot{e} + \lambda\dot{e} + \gamma) = S[(\ddot{x} - \ddot{x}_d) + \lambda\dot{e} + \gamma] \\ &= S[f(x) + bu + d - \ddot{x}_d + \lambda\dot{e} + \gamma] \\ &= S[\hat{f} + \hat{u} - \ddot{x}_d + \gamma + \lambda\dot{e}] \\ &= S[\hat{f} + u_{eq} - Ksat(S) - \ddot{x}_d + \gamma_{fuzz} + \lambda\dot{e}] \end{aligned}$$

Using the fuzzy tuned expression for the intercept value γ_{fuzz} as crisp output value

$$\dot{V} = S[\hat{f} + u_{eq} - (\eta + F)sat(S) + \gamma_{fuzz} + \lambda\dot{e} - \ddot{x}_d], \quad \eta > 0$$

$$\dot{V} \leq |S|[-(\eta + F)sat(S)]$$

The derivative of the Lyapunov function satisfies the asymptotic stability condition as

$$\dot{V} = S\dot{S} \leq -\eta|S|$$

This concludes the proof. For getting desired result of nonlinear system in terms of minimum reaching time and tracking error, so that we have to combine two approaches such as rotating and shifting sliding surface by using fuzzy logic.

4. Hitting Gain Adaptation

The auxiliary control effort or discontinuous control action should be designed to eliminate the effect of unpredictable perturbations. The auxiliary control effort is referred as hitting control law represented as u_d . In conventional SMC hitting control law is given as

$$u_d = -K \text{sat}(S) \quad (10)$$

where, K is a hitting control gain concerned with upper bound of uncertainties and $\text{sat}(\cdot)$ is a saturation function. Generally, the SMC law is described in earlier section, which is sum of equivalent and auxiliary control. However, the upper bound of uncertainties is required in SMC design and it is very difficult to obtain precisely in practical application. Therefore, fuzzy logic inference system is employed for estimating the hitting control gain.

In path tracking systems, however, the system invariance properties are observed only during the sliding phase. In reaching phase, tracking may be hindered by disturbances or parameter variations. The straightforward way to reduce tracking error and reaching time by increasing hitting gain, which may causes chattering effect. The chattering can also be reduced by using small boundary layer thickness. The selection of hitting gain value is based on minimization of tracking error and reaching time, whenever the tracking error is negative then we have to choose small gain value for desired performance of system and vice versa. The sliding hyperplane highly depend upon dynamics of error and change in error so that we have to consider this variable as input to the fuzzy logic module for updating hitting gain. By using above consideration, the general rule is composed as, if sliding surface in negative region then select small value of hitting gain and vice versa. Let the sliding surface S be the input linguistic variable of fuzzy logic and the hitting control gain K be the output linguistic variable, the associated fuzzy sets for S and K are expressed as follows:

- (a) The sliding surface S as antecedent proposition can be expressed in to three fuzzy partitions such as *Negative* (N), *Zero* (Z) and *Positive* (P)
- (b) The hitting control gain K as consequent proposition can be expressed in to three fuzzy partitions such as *Small* (S), *Medium* (M) and *Large* (L)

Then, fuzzy linguistic rule base can be design as follows:

Rule 1: If S is **N** then K is **S**

Rule 2: If S is **Z** then K is **M**

Rule 3: If S is **P** then K is **L**

The membership functions of input and output fuzzy sets are depicted in Figure 5. In this paper, the triangular membership function and centre of gravity defuzzification method are adopted, as they are computationally simple, intuitively plausible and most frequently used in literature. Then, the hitting control gain can be estimated by fuzzy logic inference mechanism. The crisp output value of hitting gain is employed for avoiding tracking error.

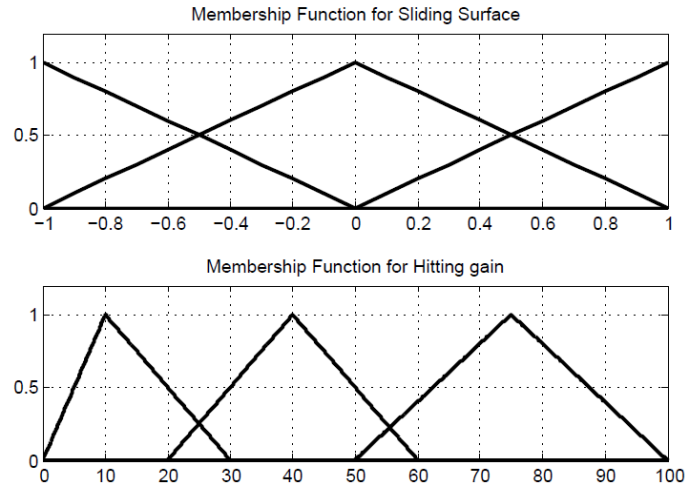

Figure 5. Membership Functions of Input-output Variables for Hitting Gain Inference System

Define a Lyapunov candidate function as

$$V = \frac{1}{2} S^2$$

The derivative of the lyapunov function with respect to time can be expressed as

$$\begin{aligned} V &= S\dot{S} = S(\ddot{e} + \lambda\dot{e}) = S[(\ddot{x} - \ddot{x}_d) + \lambda\dot{e}] \\ &= S[f(x) + bu + d - \ddot{x}_d + \lambda\dot{e}] \\ &= S[\hat{f} + \hat{u} - \ddot{x}_d + \lambda\dot{e}] \\ &= S[\hat{f} + u_{eq} - Ksat(S) - \ddot{x}_d + \lambda\dot{e}] \end{aligned}$$

Using the fuzzy tuned expression for the intercept value K_{fuzz} as crisp output value

$$\begin{aligned} \dot{V} &= S[\hat{f} + u_{eq} - K_{fuzz}sat(S) + \lambda\dot{e} - \ddot{x}_d], \quad \eta > 0 \\ \dot{V} &\leq |S|[-K_{fuzz}sat(S)] \end{aligned}$$

The derivative of the Lyapunov function satisfies the asymptotic stability condition as

$$\dot{V} = S\dot{S} \leq -K_{fuzz} |S|$$

This concludes the proof.

5. Simulation Study

The main focus of this paper is provided, the direct solution for nonlinear depth dynamics of AUV. A one-degree of freedom nonlinear underwater vehicle model is used herein to

describe the vertical motion of the AUV. The simplified nonlinear AUV model with vertical motion along z-axis can be described by [11].

$$m\ddot{z} + c\dot{z} + d = u \quad (11)$$

where, u is the control input (thrust force), d disturbances caused by external forces such as ocean currents, modeling errors and unmodeled dynamics, $c = 0.5CD_0A$ the coefficient of the hydrodynamic quadratic damping and m represent vehicles mass plus the hydrodynamic added mass. The following assumptions can be made with respect to the dynamic model of AUV.

Assumptions 1:

The vehicle's mass plus hydrodynamic added mass ie m is time varying and unknown, but it is positive and bounded in between $0 \leq m_{min} \leq m(t) \leq m_{max}$

Assumptions 2:

The coefficient of hydrodynamic quadratic damping is time varying and unknown but it is bounded in between $c_{min} \leq c(t) \leq c_{max}$

Assumptions 3:

The disturbance effect $d(t)$ is time varying and unknown but it is bounded by a known function of z, \dot{z} and t , that is $|d(t)| \leq \delta(t, z, \dot{z})$

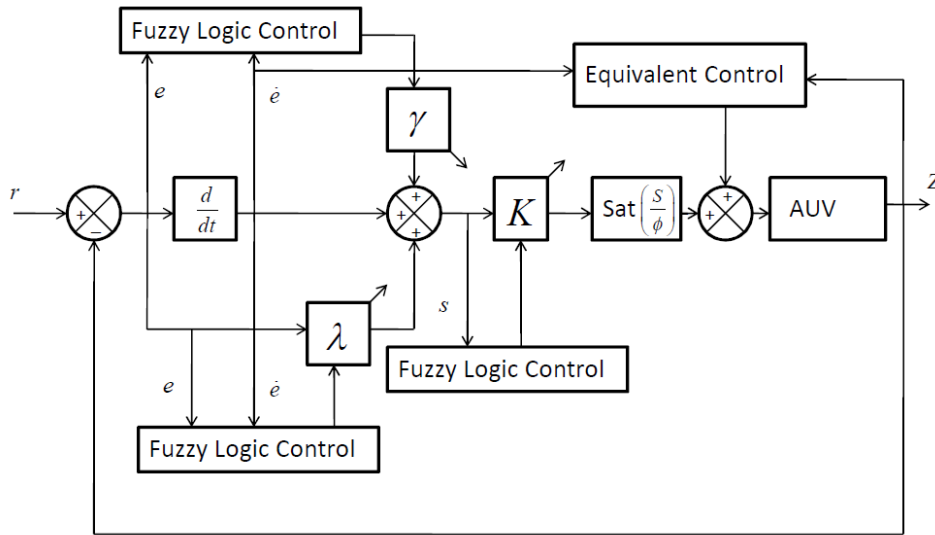

Figure 6. Block Diagram of Sliding Mode Control for AUV using Fuzzy Tuning Scheme

Here, the main objective is to control vertical motion of underwater vehicle by using adaptive sliding mode method. This control technique is applicable to nonlinear AUV model, because conventional linear control can't handles nonlinearity, modeling error, parametric variation and disturbances. The block diagram of proposed depth control system for AUV as shown in Figure 6, in which fuzzy tuning scheme is employed for updating the parameters of SMC such as sliding slope, intercept of sliding plane and hitting gain. The adaptive SMC algorithm is presented for compensation of uncertainties and external disturbances.

Now, let the problem of controlling the vertical motion of AUV governed by Eq. (11), can be solved by defining a control law composed by an equivalent control is given as follows:

$$u = c\dot{z}|\dot{z}| + d + m(\ddot{z}_d - \lambda\dot{z}) \text{ and discontinuous term } -K \text{ sat}(S)$$

The sliding mode control law defined as

$$u = c\dot{z}|\dot{z}| + d + m(\ddot{z}_d - \lambda\dot{z}) - K \text{ sat}(S) \quad (12)$$

The fuzzy logic tuning scheme is applied to nonlinear underwater vehicle in three stages. In first stage of tuning, hitting gain K is fixed constant and intercept of siding surface is neglected. Fuzzy adaptation of sliding slope is required for rotation of sliding hyperplane as shown in Figure 7. The sliding slope inference system employed for accelerating reaching time and reducing tracking error.

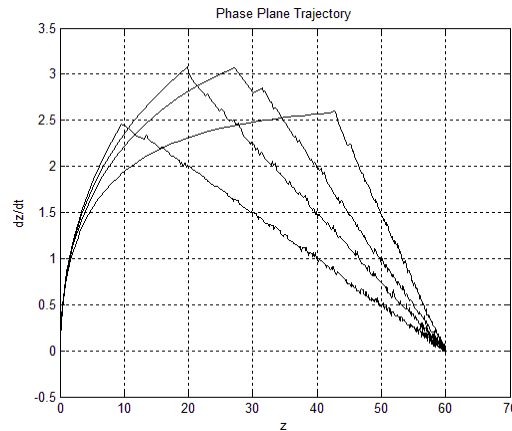

Figure 7. Rotation of Sliding Surface

During second stage, sliding slope and hitting gain is a fixed constant value, while intercept of sliding plane is tuned by fuzzy logic module. The shifting of sliding surface as shown in Figure 8, depends on the state of error and change in error. In the last stage of tuning method, sliding slope is a fixed constant and intercept of sliding surface is neglected, while the hitting control gain is updated by fuzzy inference system for fast tracking response, which causes variations of approaching angle as shown in Figure 9. These three tuning approach are combined together for best performance of AUV model in vertical plane with minimum reaching time and fast tracking response.

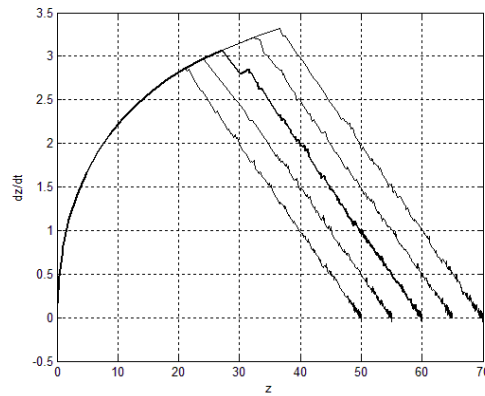

Figure 8. Shifting of Sliding Surface

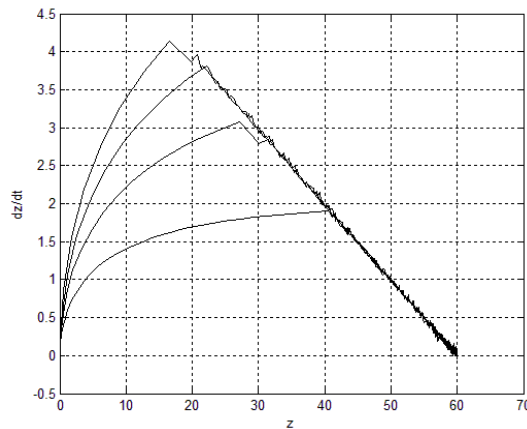

Figure 9. Variation of an Approaching Angle

In order to evaluate the control system performance, two different numerical simulations were performed. In the first case, it was considered that model parameters m and c were perfectly known. Regarding conventional SMC and vehicle parameters, the following values were chosen $m = 50$ kg, $c = 250$ kg/m, $K = 20$, $\lambda = 0.2$ and $\phi = 0.01$. The disturbances force was chosen as sampled Gaussian noise as shown in Figure 10, which can be compensated by SMC due to that better tracking performance is obtained. In the presence of external disturbances, proposed controller as SMC with fuzzy tuning was applied for controlling the nonlinear depth parameter of AUV. Figure 11 (a) and (b) shows set point tracking response and phase trajectory of AUV by using SMC and fuzzy adapted SMC. The reaching time of both controllers can be analyzed from speed of convergence plot as shown in Figure 12. The Adaptive SMC is able to provide trajectory tracking with a small associated error and disturbances effect. It can also verified that the proposed control law provide a smaller tracking error and reaching time when compared with the conventional SMC as shown in Figure 13.

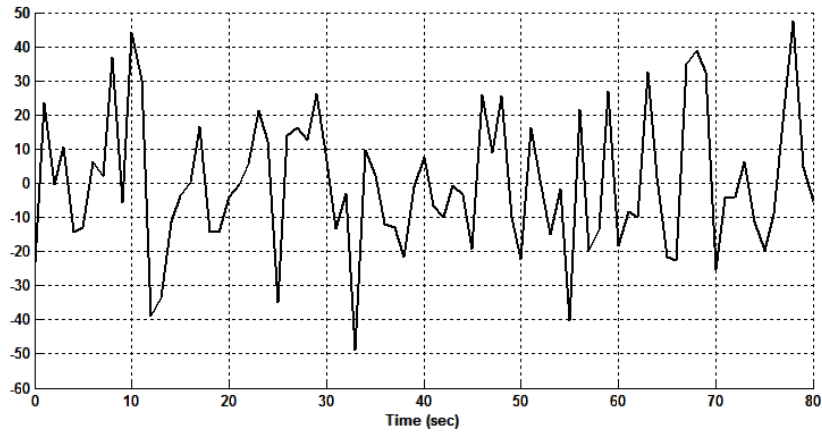

Figure 10. Sampled Gaussian Noise

In second case, the parameter of AUV considered with a maximal uncertainties of $\pm 10\%$ over previous adopted values, where $m = 55$ kg and $c = 275$ kg/m. The other parameters as well as the disturbance forces and desired trajectory were defined as before. Figure 14 shows comparative analysis between SMC and fuzzy adapted SMC for depth control AUV in terms of set point tracking response. During controller design exact mathematical model and the estimation of upper bounds on uncertainties of the system were not required, only necessary information about the qualitative knowledge of the system such as operating range and its nominal model. The simulations were performed by employing the proposed tuning technique which able to handle external disturbances and parameter variations. From simulation results, it is clear that sliding mode control with fuzzy tuning technique is able to provide significant fast and robust tracking performance with reduced reaching time.

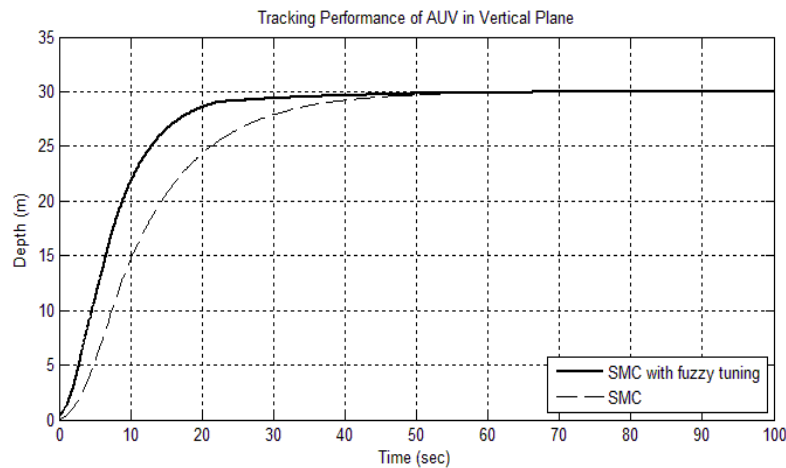

Figure 11(a). Set Point Tracking Response of AUV in Vertical Plane

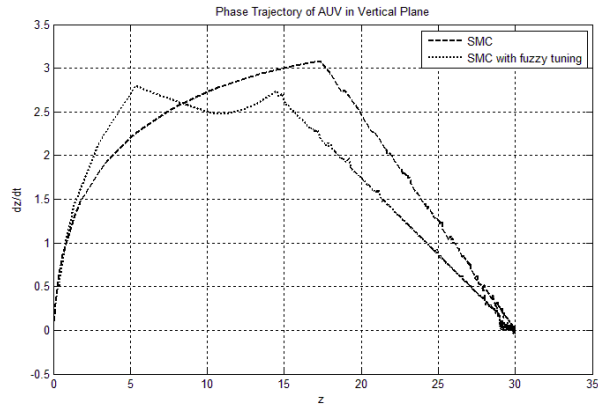

Figure 11(b). Phase Plane Response of AUV in Vertical Plane

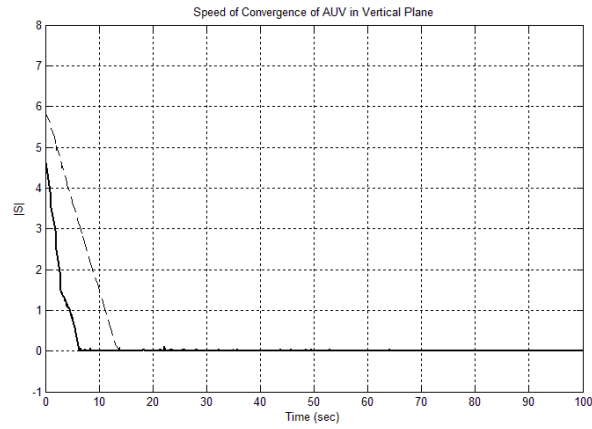

Figure 12. Speed of Convergence of AUV

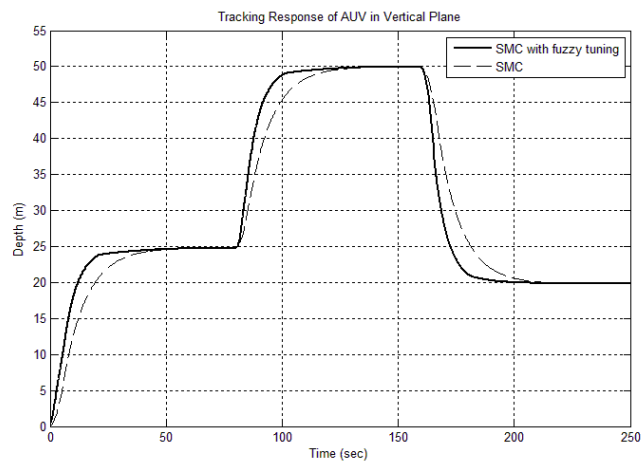

Figure 13. Transient Response of AUV in Vertical Motion Control

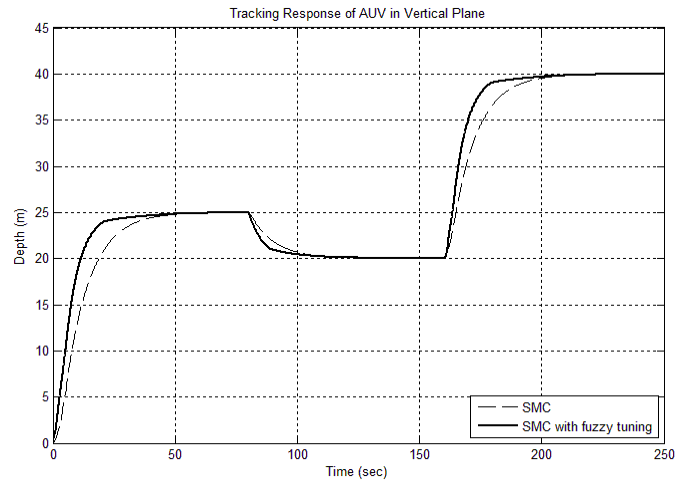

Figure 14. Transient Response of AUV with Parametric Uncertainties

6. Conclusion

This paper described the design and implementation of a sliding mode controller with fuzzy logic tuning approach. The fuzzy adopted tuning strategy applied to the sliding mode control algorithm for rotating and/ or shifting the sliding plane according to the tracking error. Due to fuzzy tuner, sliding surface continuously moving for significantly reduces reaching time and substantially enhances the system performance which is insensitive to the parameter variations and disturbance effects. This control strategy establishes the appropriate fuzzy rules by continuous on line learning instead of trial and error procedure. The estimation of sliding slope, intercept of sliding surface and hitting gain can be solved by implementation of fuzzy tuner. The computation time and data base requirements can be reduced with help of proposed algorithm. Here, Lyapunov analysis is employed to investigate the stability property of each tuning technique. The simulation results of an AUV verified the efficiency and robustness of the proposed tuning technique and it was comparatively superior to conventional SMC in the sense of tracking performance and phase trajectory response.

References

- [1] S. B. Choi, D. W. Park and S. Jayasuriya, "A time-varying sliding surface for fast and tracking control of second-order dynamic systems", *Automatica*, vol. 30, (1994), pp. 899-904.
- [2] J. P. V. S. Da Cunha, R. R. Costa and L. Hsu, "Design of a high performance variable structure control of ROV's", *IEEE Journal of Oceanic Engineering*, vol. 20, no. 1, (1995), pp. 42-55.
- [3] T. I. Fossen and S. Sagatun, "Adaptive control of nonlinear systems: A case study of underwater robotic systems", *Journal of Robotic Systems*, vol. 8, (1991), pp. 393-412.
- [4] K. Furuta, "VSS type self-tuning control", *IEEE Trans. Ind. Electron.*, vol. 40, (1993), pp. 37-44.
- [5] Q. P. Ha, "Robust sliding mode controller with fuzzy tuning", *IEE Electron. Lett.*, vol. 32, (1996), pp. 1626-1628.
- [6] Q. P. Ha, "Sliding performance enhancement with fuzzy tuning", *IEE Electron. Lett.*, vol. 33, (1997), pp. 1421-1423.
- [7] Q. P. Ha, D. C. Rye and H. F. Durrant-Whyte, "Fuzzy moving sliding mode control with application to robotic manipulators", *Automatica*, vol. 35, (1999), pp. 607-616.
- [8] Y. S. Lu and J. S. Chen, "A self-organising fuzzy sliding-mode controller design for a class of nonlinear servo systems", *IEEE Trans. Ind. Electron.*, vol.41, (1994), pp. 492-502.

- [9] H. -P. Pang, C. -J. Liu and W. Zhang, "Sliding Mode Fuzzy Control with Application to Electrical Servo Drive", IEEE International Conference on Intelligent Systems Design and Applications, (2006), pp. 320-325.
- [10] S. -H. Ryu, J. -H. Park, "Auto-Tuning of sliding mode control parameters using fuzzy logic", American Control Conference, vol. 1, (2001), pp. 618-627.
- [11] J. J. Slotine and W. Li, "Applied Nonlinear Systems", Prentice-Hall, (1991).
- [12] S. K. Spurgeon, "Choice of discontinuous control component for robust sliding mode performance", Int. J. Control, vol. 53, (1991), pp. 161-179.
- [13] H. Temeltas, "A fuzzy adaptation technique for sliding mode controllers", IEEE International symposium, vol. 1, (1998) July, pp 110-115.

Authors



Mr. G. V. Lakhekar received M. Tech degree (2009) from the S. G. G. S. Institute of Engineering and Technology in S. R. T. Marathwada university, Nanded, M.S, India and the B.E. degree (2007) from the M. B. E. S. College of Engineering, Ambajogai in Dr. Babasaheb Ambedkar Marathwada University, Aurangabad. His field of interest includes Intelligent Control, Process Control and Sliding Mode Control. He is working as an Assistant professor in Department of Instrumentation Engineering, M. B. E. S. College of Engineering, Ambajogai, M.S, India. Life member of Indian society for technical education, New Delhi.

