

Security Augmenting Scheme for Bus Information System based on Smart Phone

Seungcheon Kim

Dept of Information Communication Engineering, Hansung University, Korea
kimsc@hansung.ac.kr

Abstract

With the smart phone app, BIS can be implemented easily and conveniently without big cost. This BIS system, however, has a weak point that the location information of the bus can be revised easily. For the purpose of augmenting the security aspect of the proposed BIS service, this paper introduces the security augmenting scheme for the bus information system that is composed of the smart phone app without extra infrastructure like wireless LAN or wireless relay system.

Keywords: *BIS System, Security Augmenting, Smart-Phone*

1. Introduction

With the start of 21st century, the expansion and the evolution of the mobile communication started to cause the change of life style of normal people. In addition, the people's lives have been changed enormously with the invention of smart-phone, which was around the year 2010.

The smart-phone enabled us to think again about every convenient system around us because it has a various abilities that can change the system without any cost. One of those systems is bus information system (BIS). BIS has been devised to provide people with the information of bus location and arrival time, *etc.* But usually BIS requires huge cost to build the basic infrastructure for the service. Therefore, the small bus company or school bus system could not afford to buy BIS even though they need the system desperately [1]. The reason for them to have BIS is because BIS can provide the location services to the students and parents through Internet. BIS, therefore, can be said to be helpful in providing security services of students.

In this paper, we focused in providing BIS services with low cost. We proposed the system architecture based on smart-phone and specific APP with server, which can provide BIS service without big cost. While devising the system architecture of BIS, however, we found the security problem that could possibly affect the whole system operation. This paper is trying to solve the problem by proposing the security augmenting system to the BIS based on smart-phone.

In this paper, therefore, you can find the system architecture of BIS and security augmenting system for BIS together. And also the implementation of the proposed BIS is introduced with the operating scene of BIS.

2. BIS: Bus Information System

Bus Information System (BIS), which is sometimes known as passenger system in other countries out of Korea, means a system that can provide bus information such as route, arrival

time transit information to help passengers with effective transit decision. For this normal BIS services, usually huge communication infrastructure is required as shown in Figure 1 [2].

This system like in Figure 1 could enjoy many benefits of real-time BIS. However, it requires huge cost to construct the support system. As you can see in the figure, first of all normal BIS requires buses to be equipped with the wireless communication devices like CDMA or WiFi. Then each bus is required to be positioned with GPS equipments. The location from the GPS system in the bus should be delivered the local server to update the location information of the bus. And this information should be delivered to the passenger information board in the bus station. Therefore the buses should be equipped with lots of expensive gadgets to provide BIS services to passengers [3, 4].

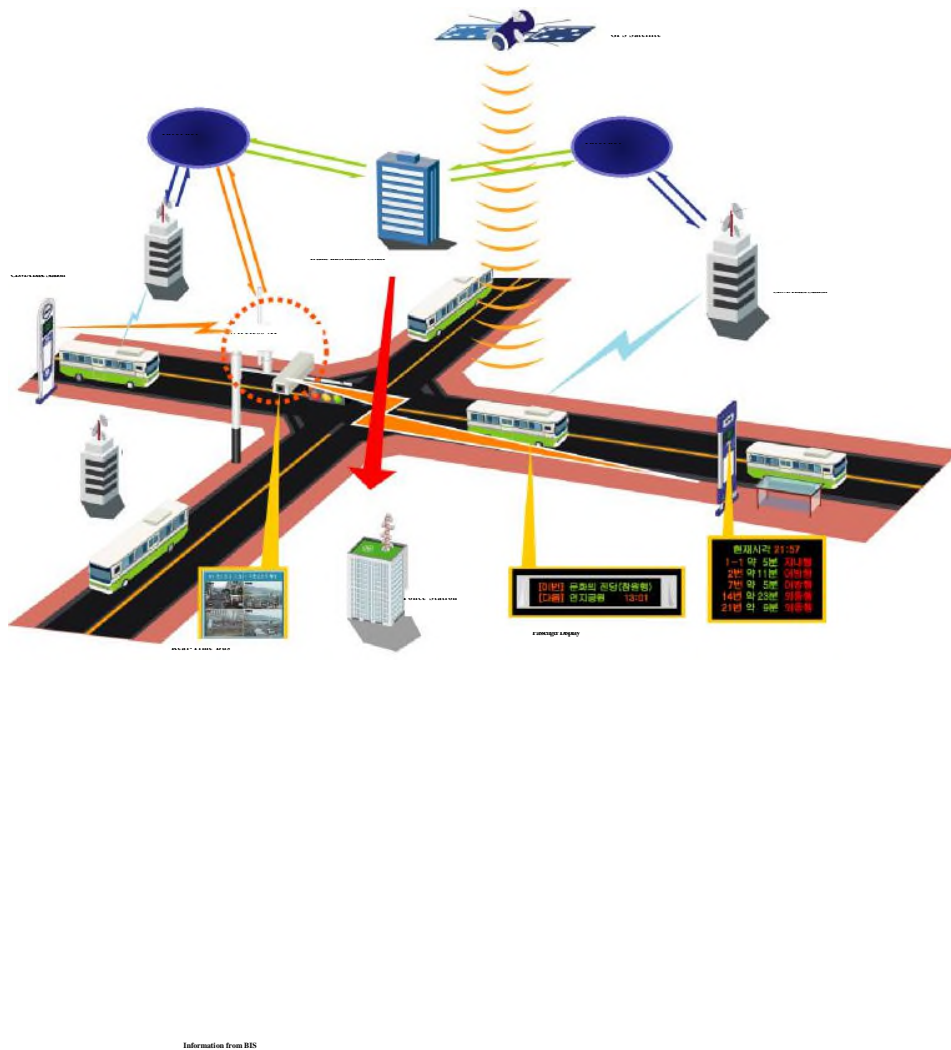

Figure 1. Normal bus information system

Therefore, lots of small bus companies like school bus or private institute bus could not afford to provide the BIS services to the clients even though the service is required for the security reason for students. To provide BIS services with small cost, this paper introduces 338 BIS based on smart-phone and explain the security matter related to the system operation.

And the security augmenting system for BIS will be proposed with the operating algorithm.

2.1 Bus Information System based on Smart-Phone

These days smart-phone has many features like camera, GPS, many sensors and lots of other personal programs. With the some functions of smart-phone, we can simulate the BIS services. Figure 2 shows the architecture of BIS based on Smart-phone.

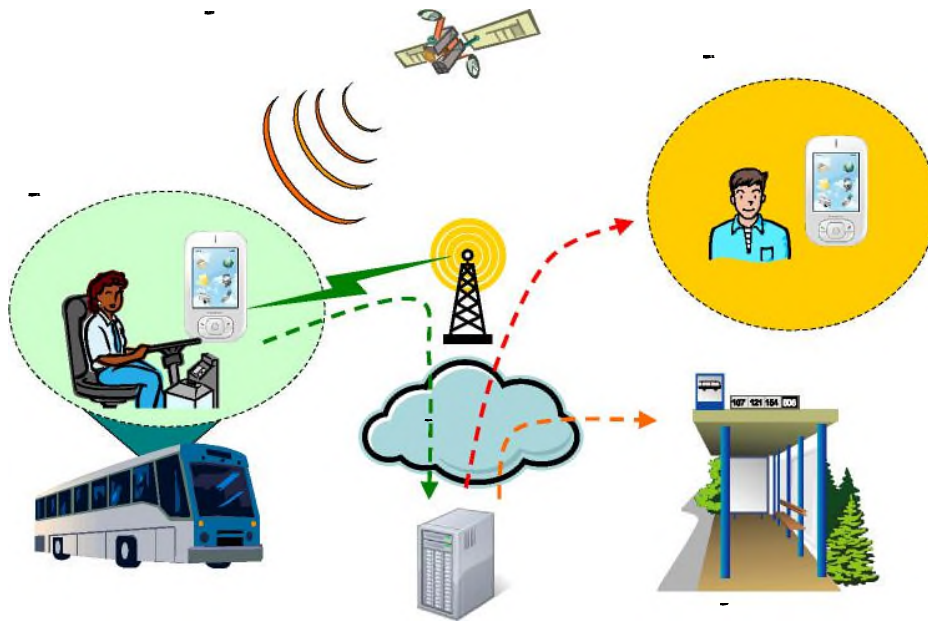

Figure 2. Bus information system based on Smart-Phone

As we can see in Figure 2, the proposed BIS requires the driver's smart-phone to deliver the bus location information to the local server. And passengers can find bus information like arrival time through passenger's smart phone or display panel in bus station. Since the normal smart-phone can deliver its GPS location through 3G or 4G mobile network to the dedicated server, the local server can elaborate the bus location information after collecting information from the driver's smart-phone.

For this, we need special application program for driver's smart-phone and server program. The driver's smart phone should act like the device equipped in the bus in normal BIS. It should be able to send the bus location after it receives GPS information from satellite.

Also the local server needs to provide the bus information to normal passengers through Internet. Therefore, server should provide web service for Internet users and distribute the

information for APP users in order that passengers can find bus information through their smart-phone or display panel connected to Internet.

To provide BIS services satisfactorily to passengers, the driver's smart-phone and the local location server are most important in BIS based on smart-phone. Detailed features are explained in Figure 3. As shown in Figure 3, driver's smart-phone has to collect GPS information from satellite when the bus is running on schedule while the designated driver is driving the bus. The driver's smart-phone should send the GPS information with the bus identification to local location server periodically to make sure the server follow its location. The local location server needs to provide the bus location information after collecting and processing the information from the bus. Since the information should be provide in many ways, local server should make various forms of information for passengers. Those would be normal web, mobile web, text information for bus station panel and information for smart-phone users.

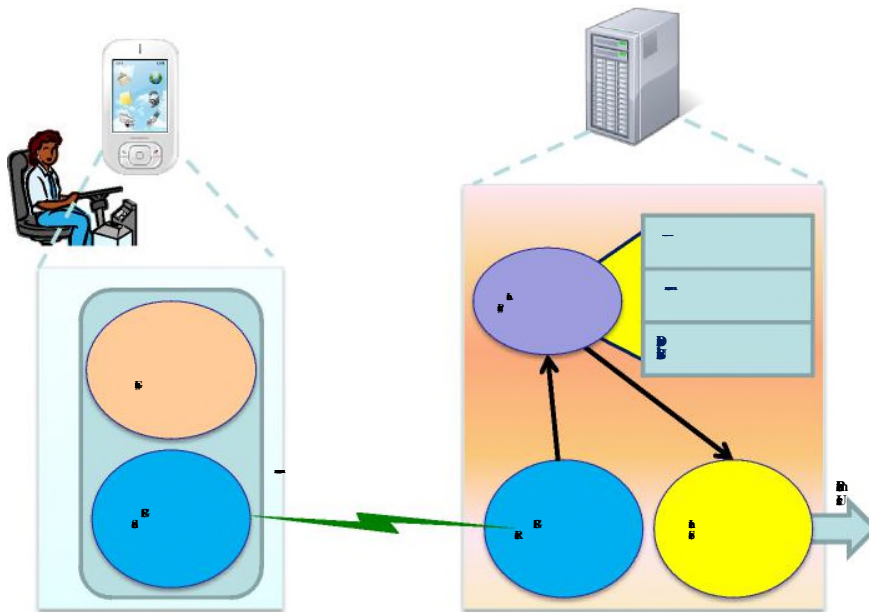

Figure 3. Process architecture for BIS based on smart-phone

GIS

2.2 Security matter in bus information system based on Smart-Phone

The proposed BIS based on smart-phone has a critical problem in security aspect. The problem is that the location information of the dedicated bus is totally dependent on the driver's location because the driver's smart phone is the device that sends the bus information to the local location server.

Therefore there could be a case that the driver's application for BIS is operating without any thought while the driver is not driving the bus. And also the driver's application can possibly send other bus information when the driver changed the bus. This might cause the big flaws in the proposed BIS based on smart phone.

Every information system has to be equipped with the proper security system for the perfection of the services. To prevent those malfunctioning case and augment security aspect of the proposed BIS, we propose the security augmenting scheme for BIS based on smart-phone.

3. Security augmenting scheme for BIS

To augment the security aspect of the proposed BIS based on smart-phone, the small device that can communicate in short range wirelessly need to be attached to every bus, which can identify each bus with special code assigned to each bus. This is described in Figure 4.

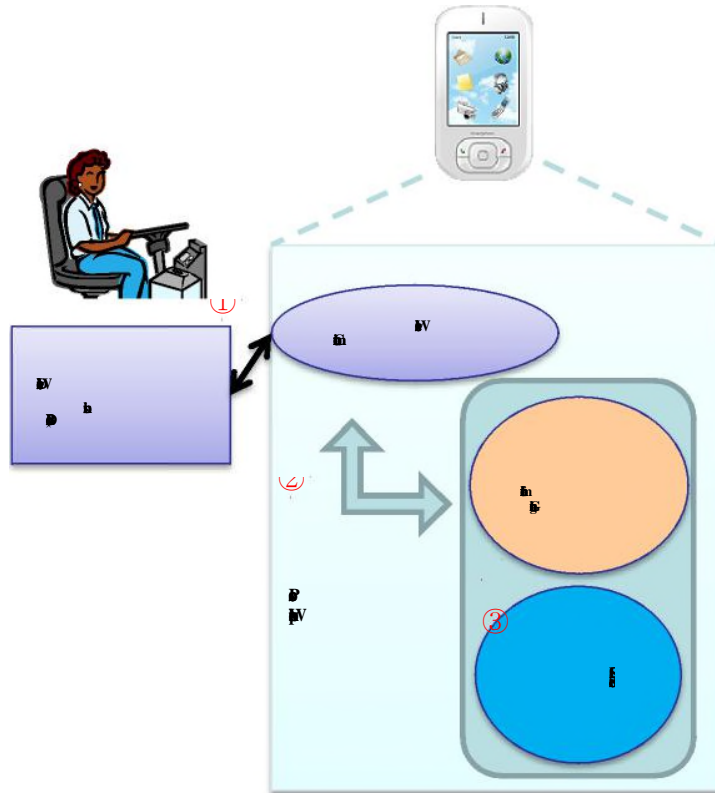

GPS



Figure 4. Process architecture in driver's smart-phone

As shown in Figure 4, in order to activate the driver's application for BIS, the driver's smart phone is required to get a special code through wireless communication from the device attached to the bus. In other words, when the driver operate the driver's APP for BIS, the checking process in the APP start to communicate with the wireless device attached to the bus and verify the bus. If the verification process was successful, this process wakes up other processes to perform its mission. The process that is required to get the GPS information from satellite is waken up by the verification process. After getting GPS information from satellite, this information is sent to the sending process that is designed to send GPS information through WIFI or mobile interfaces like 3G/4G.

With the wireless device attached to the bus, the driver's smart-phone continues to communicate to verify whether the driver is still driving in driver's seat. Otherwise, the communication session would break shortly and the BIS APP in driver's smart-phone would inform the local server that the driver has quitted driving the bus. This whole operation is described as a flowchart in Figure 5.

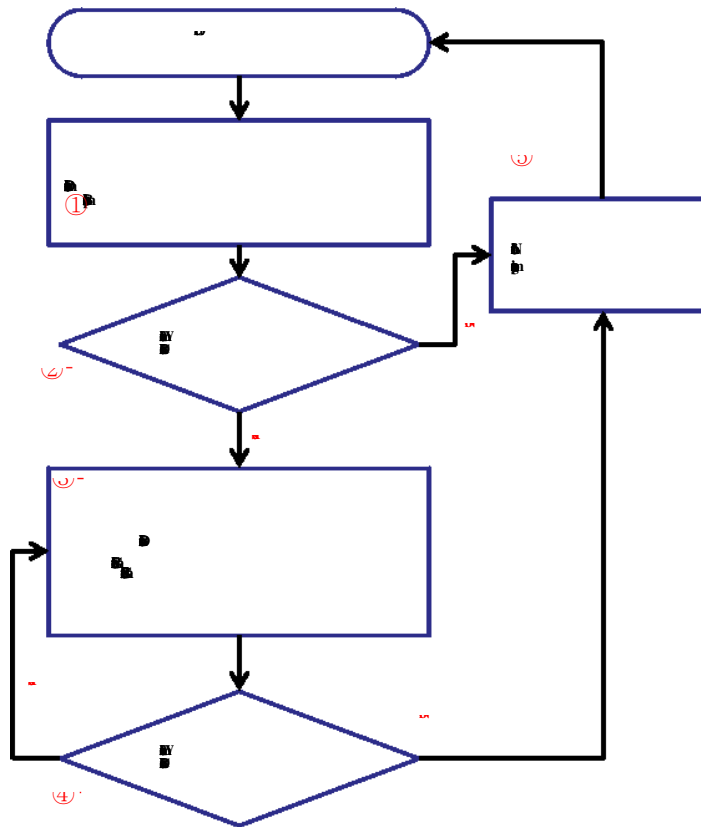

Figure 5. Flow of processing for verification bus ID

- ① Once the driver start to operate the BIS APP in driver's smart-phone, the BIS APP in driver's smart phone tries to communicate the wireless device in the bus that has the bus ID.
- ② When BIS APP in driver's smart phone succeeded in communicating with the wireless device in the bus, it continues to next step. Otherwise, the BIS APP in driver's smart phone pops message saying that it cannot perform the BIS service.
- ③ Once the BIS APP is successful in getting the bus ID through wireless device in the bus, it start to collect the GPS information and send them to the local location server through smart-phone mobile interface, which is connected to Internet via 3G/4G mobile network.
- ④ Once the BIS APP in the driver's smart-phone succeeded in sending GPS information to server, it should check the availability of wireless device to see the driver is still in the bus.
- ⑤ If the BIS APP in the driver's smart-phone cannot access the wireless device and get the bus ID anymore, it should issue the message that the BIS service cannot be sustained any longer. And the BIS APP in the driver's smart-phone should kill itself.

4. Implementation of BIS based on smart phone

We have implemented the BIS proposed in the paper. The implementation of the BIS is based on the architecture in Section 2. The system is mainly composed of three parts: The driver's APP in smart phone, the location server and the user's APP to see the location of the bus.

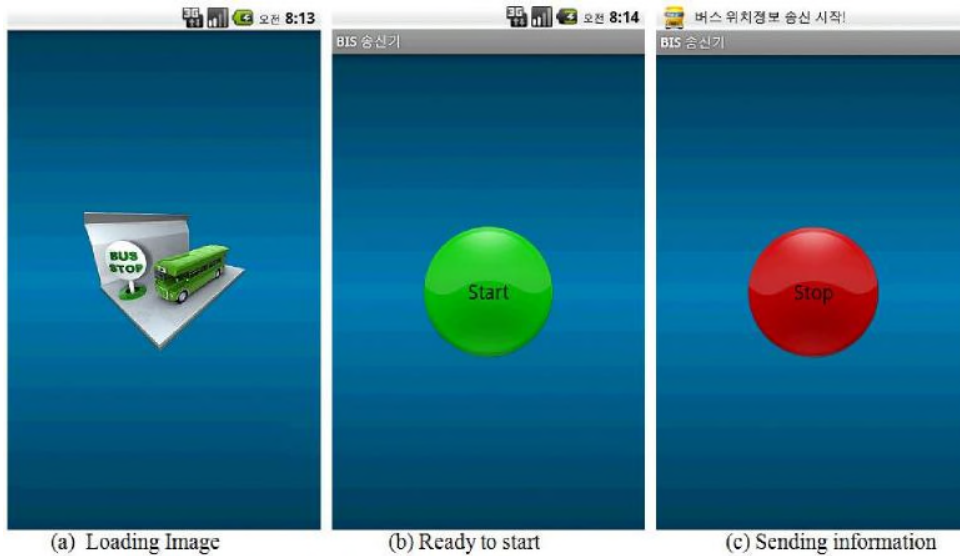

Figure 6. APP for location sending in driver's smart-phone

Figure 6 shows the driver's APP for getting the location information of the bus and sending the information to the location server. When you start the APP, the first image of the APP is (a) of Figure 6. Then the APP will show the (b) of Figure 6 when it is ready to operate. When the driver press the start button, it will start to operate and show the (c) of Figure 6.

As explained in Section 3, the driver's APP will begin its operation by start to verify the bus through wireless communication. In our implementation, the BlueTooth was used. When the verification was successful, the driver's APP starts to collect the GPS information and send this information to the location server.

The server was implemented as shown in Figure 7. This server collects the GPS location information periodically and updates this information when it receives location information from the driver's APP.

The BIS users can use the passenger APP or Internet access to see the bus location, which is shown in Figure 8. In order for users to see the bus location through Internet with web browser, the server provides the web service. And the server also provides the location information to the user's APP.

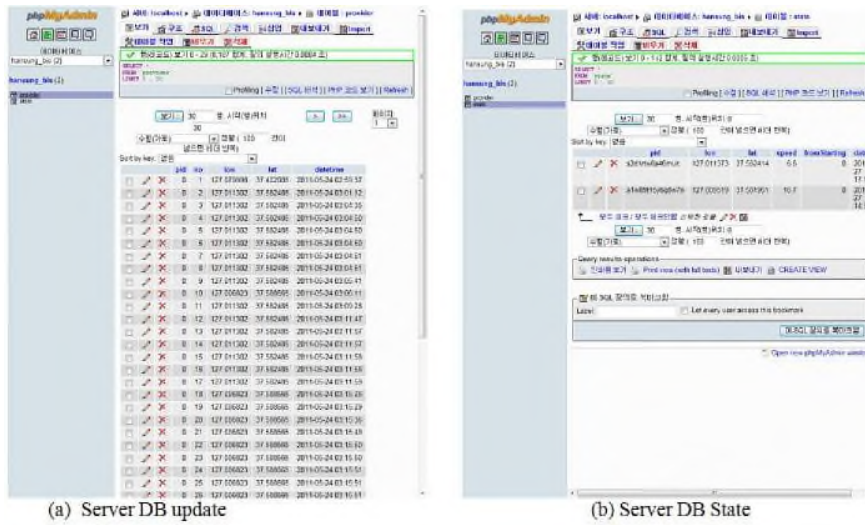

Figure 7. Location Server

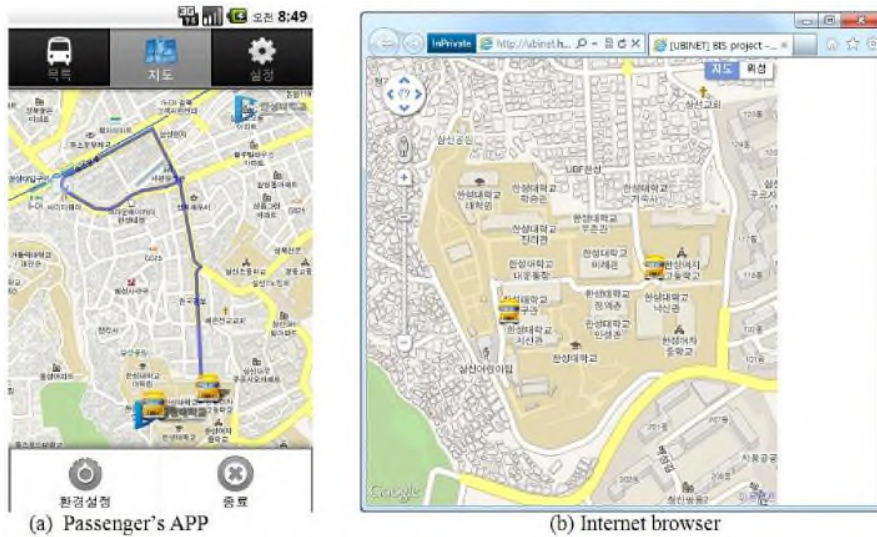

Figure 8. User access for bus location

5. Conclusions

This paper has introduced the new bus information system based on smart-phone. Since the smart phones are multi tasking and very resourceful these days, we can replace many usual expensive systems with APPs in smart phones. The same idea has been adopted in the proposed BIS. But the proposed BIS has the security problem that could create serious problem when it is used in real situation. To prevent this security problem, the security augmenting scheme has been proposed in this paper. With the proposed scheme, the proposed BIS based on smart phone is expected to provide bus information services with very low cost.

Acknowledgments

This Research was financially supported by Hansung University.

References

- [1] Y. Lee, "A Study for Communication Mode of Bus Information System", Journal of Korean Society of Industrial Application, vol. 10, no. 4, (2007).
- [2] D. Choi, "Arrival Time Guidance System of Circular Vehicles Using GPS and CDMA/Internet", Journal of Korean contents society, vol. 6, no. 5, (2006).
- [3] N. -G. Cho and H. -k. Lee, "Possibility of the HST (High Speed Train) for Commuting Trip", The Korea Spatial Planning Review, vol. 41, pp. 70-81.
- [4] K. S. Kim, "Stated Preference Design and Analysis (the second phase)", The Korea Transport Institute Research, pp. 97-105.

Authors



Seungcheon Kim

He has received the B.S., M.S. and Ph.D. degrees in Electronic Engineering Department of Yonsei University, Seoul, Korea, in 1994, 1996 and 1999, respectively. He is currently with the Department of Information and Communication Engineering, Hansung University, Seoul, Korea, where he is responsible for teaching and research in wireless data communication networks, and ubiquitous sensor networks. He has worked as a post doctoral research fellow in the School of Electrical and Information Engineering in the University of Sydney, Australia, from 2000 to 2001, where he conducted research about 4G Mobile Wireless Communications. He's also worked as a senior research engineer in the Home Network Group of Digital TV Laboratory and the Digital Tech. Group of DA Laboratory, LG Electronics Inc., from 2001 to 2003, where he designed the Home Network Protocol and developed several Home Networking Devices. He has served as a director of Industrial cooperation research center in Hansung University. He was a visiting scholar in the department of computer science in the University of Oregon, United States, from 2009 to 2010. His research interests include the traffic managements in Wireless and mobile communication networks, architectures of 4G Wireless Networks and the design of Home Networking Protocol and Ubiquitous Network Architecture.

